

RepRap Clone Wars electronics

SAU Mk-I

3D printer electronics from the Clone Wars Project
http://reprap.org/wiki/SAU_MKI

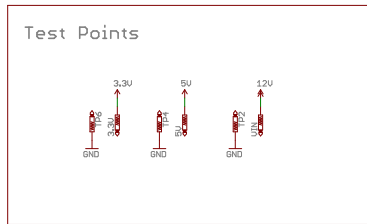
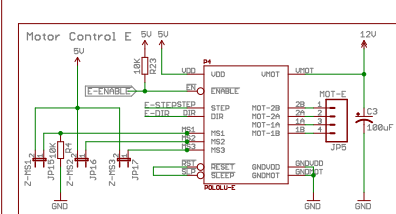
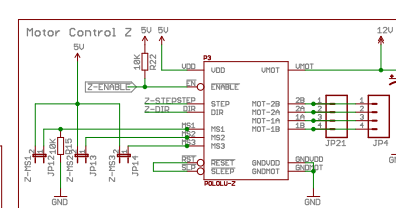
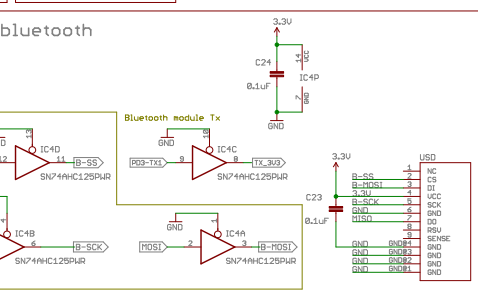
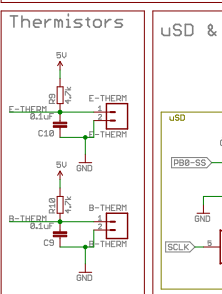
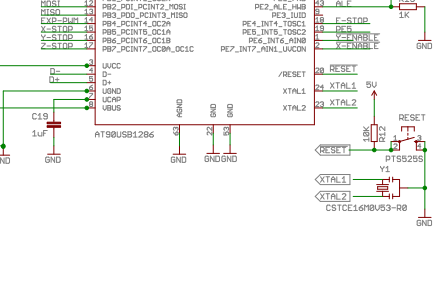
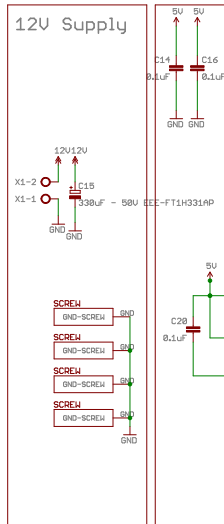
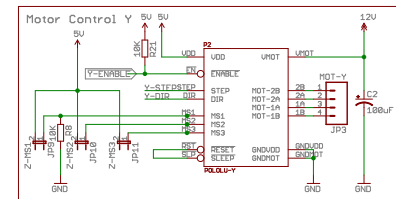
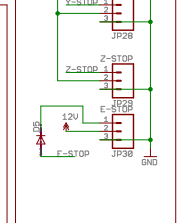
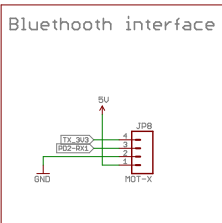
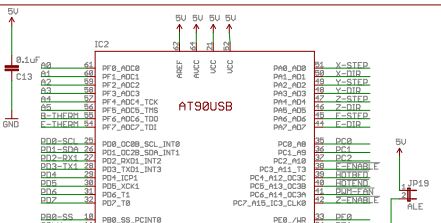
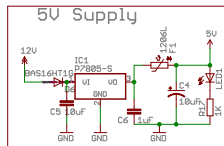
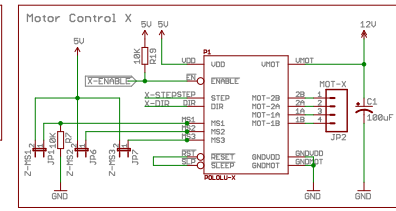
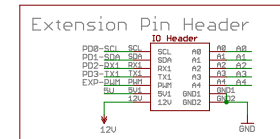
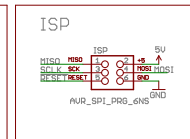
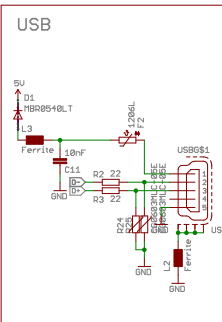
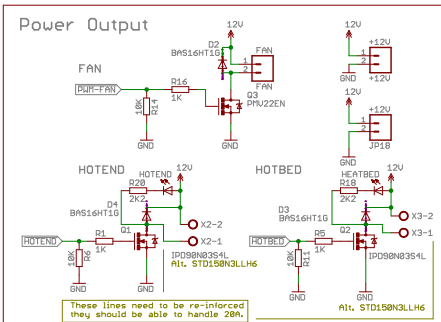
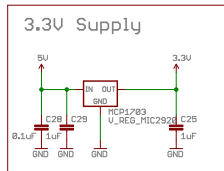

Project Supporters and collaborators

Clone Wars RepRap community
 RepRap Zaragoza
 Luis Villarrubies
 Jose Antonio Perez
 Pascual Alagon
 Carlos Garcia
 Javier Pajares
 Jose M. Martin
 Francisco Javier Sanchez
 Antonio Javier Lopez
 Manuel Palacios
 Juan Manuel Amuedo - @LE Adri
 Chema Muñoz
 Luis Haciaés

Ignacio Gininas
 Santiago Lopez
 Valentin Canceias
 Antonio Javier Lucas
 Clinica Veterinaria Noso Can
 Arturo Pueyo
 Shutt13D
 jgalarron
 Ark
 Fib

Special thanks to Andreu

Released under the Creative Commons Attribution Share-Alike 3.0 License
<http://creativecommons.org/licenses/by-sa/3.0> Design based on the Teensylu form factor and pinouts.



SAU Mk-I

TITLE: SAU Mk-I by fm - fmalpartida

Document Number: **electroFUN LTD (www.electrofundtd.com)** REV: **D**

Date: 22/08/16 14:33 Sheet: 1/1

THIS DESIGN IS PROVIDED BY THE COPYRIGHT HOLDERS AND CONTRIBUTORS "AS IS" AND ANY EXPRESS OR IMPLIED WARRANTIES, INCLUDING, BUT NOT LIMITED TO, THE IMPLIED WARRANTIES OF MERCHANTABILITY AND FITNESS FOR A PARTICULAR PURPOSE ARE DISCLAIMED. IN NO EVENT SHALL THE AUTHOR BE LIABLE FOR ANY DIRECT, INDIRECT, INCIDENTAL, SPECIAL, EXEMPLARY, OR CONSEQUENTIAL DAMAGES (INCLUDING, BUT NOT LIMITED TO, PROCUREMENT OF SUBSTITUTE GOODS OR SERVICES); LOSS OF USE, DATA, PERSONAL OR MATERIAL DAMAGE, PROFITS OR BUSINESS INTERRUPTION) HOWEVER CAUSED AND ON ANY THEORY OF LIABILITY, WHETHER IN CONTRACT, STRICT LIABILITY, OR TORT (INCLUDING NEGLIGENCE OR OTHERWISE) ARISING IN ANY WAY OUT OF THE USE OF THIS DESIGN, EVEN IF ADVISED OF THE POSSIBILITY OF SUCH DAMAGE. Furthermore, the author reserves the right to make any modifications to the design without prior notice.

Released under the Creative Commons Attribution Share-Alike 3.0 License Design based on the Teensylu form factor and pinouts. <http://creativecommons.org/licenses/by-sa/3.0> SAU Mk-I by fm - fmalpartida